

1

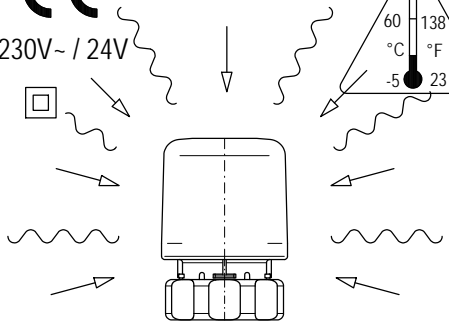

230V~ / 24V

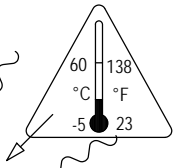

2

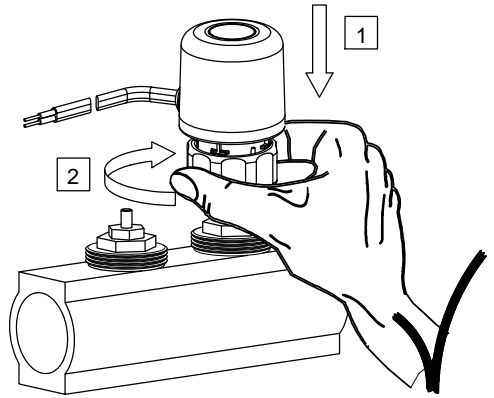

3

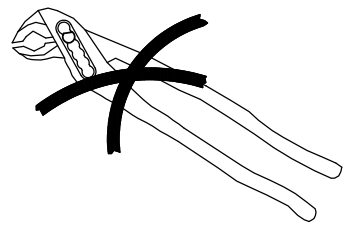
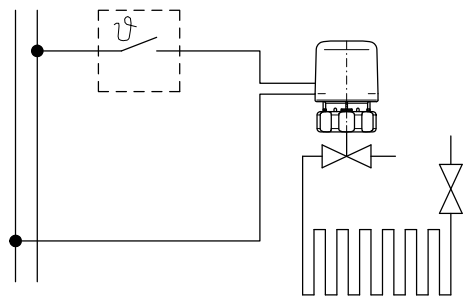

4

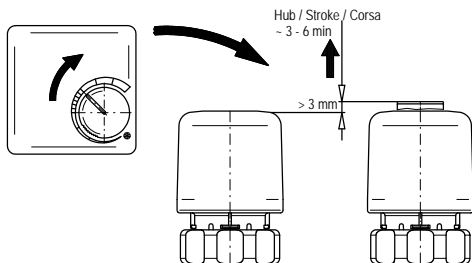

6

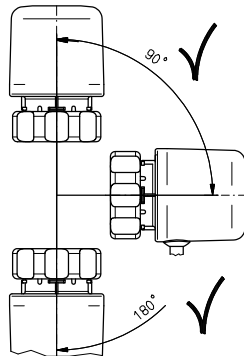

IP 54

5

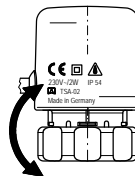
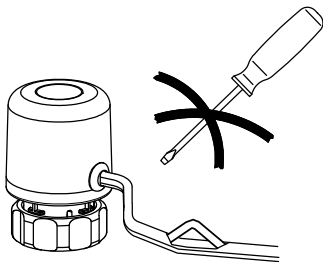

U = 24 V ±10%
P ~ 2 W
I_{max} ~ 184 mA
I_N ~ 84 mA
CE IP 54 ☐
-5°C ... 60°C
F ~ 90 N
Typ: TSA 02 ☒

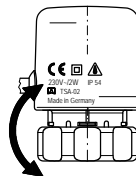

U = 230 V ~ ±10%
P ~ 2 W
I_{max} ~ 140 mA
I_N ~ 9 mA
CE IP 54 ☐
-5°C ... 60°C
F ~ 90 N
Typ: TSA 02 ☒