

## Thermometer-hydrometer TH



### Benefits

- Pressure and temperature measurement with at a single measuring point
- With self-sealing connection thread for fast installation
- With mounting valve for easy replacement without downtime

### Application

For liquid media which are not highly viscous, do not crystallise and do not attack copper alloys. For combined measurement of pressure and temperature, especially in heating systems and heating boilers.

### Description

The combined thermometer/pressure gauge / thermo-hydrometer consists of a Bourdon tube measuring system for pressure measurement and a bimetal measuring system for simultaneous temperature measurement. Both values are measured and displayed by a single gauge. A self-closing mounting valve enable easy replacement of the measuring instrument without requiring the system to be drained. An optional M18 x 1 to G $\frac{3}{4}$  adapter is available if the combined thermometer/pressure gauge has to be mounted into an existing thermowell with M18 x 1 female thread.

### Technical specifications

#### Type

D2

#### Nominal size

80

#### Accuracy class

Pressure gauges: 2,5 (EN 837-1/6)

#### Range

Pressure: 0/6 mWS 0/10 mWS 0/16 mWS 0/25 mWS  
0/40 mWS 0/60 mWS

Temperature: 20/120 °C

#### Application area

Pressure

Static load:  $\frac{1}{4}$  x full scale value

Dynamic load:  $\frac{1}{3}$  x full scale value

Short-term: Full scale value

Temperature: Full scale value

#### Operating temperature range

Medium: Max. 120 °C

Ambient: -20/+60 °C

#### Temperature performance

Pressure: Indication error when the temperature of the measuring system deviates from the normal temperature of 20 °C:

Pressure: at rising temperature approx.  $\pm 0.4 \%$ /10 K

Pressure: falling temperature approx.  $\pm 0.4 \%$ /10 K

Pressure: of full scale value

#### Degree of protection

IP 32 (EN 60529)



### Standard version

#### Connection

Brass, centre back  
G $\frac{1}{4}$ B with mounting valve G $\frac{1}{4}$  to R $\frac{1}{2}$

#### Measuring element

Pressure: Bourdon tube, Copper alloy  
Temperature: Bimetal spiral

#### Dial

Plastic, white  
Scaling black with red/blue circular arcs

#### Pointer

Pressure: Plastic, black  
Temperature: Plastic, Red

#### Housing

Sheet steel, black

#### Window

Plastic, clipped in with adjustable red mark

### Options

- Adapter M 18 x 1 to G $\frac{1}{4}$
- Special scales
- Other process connections

### Detail views

#### Mounting valve and adapter

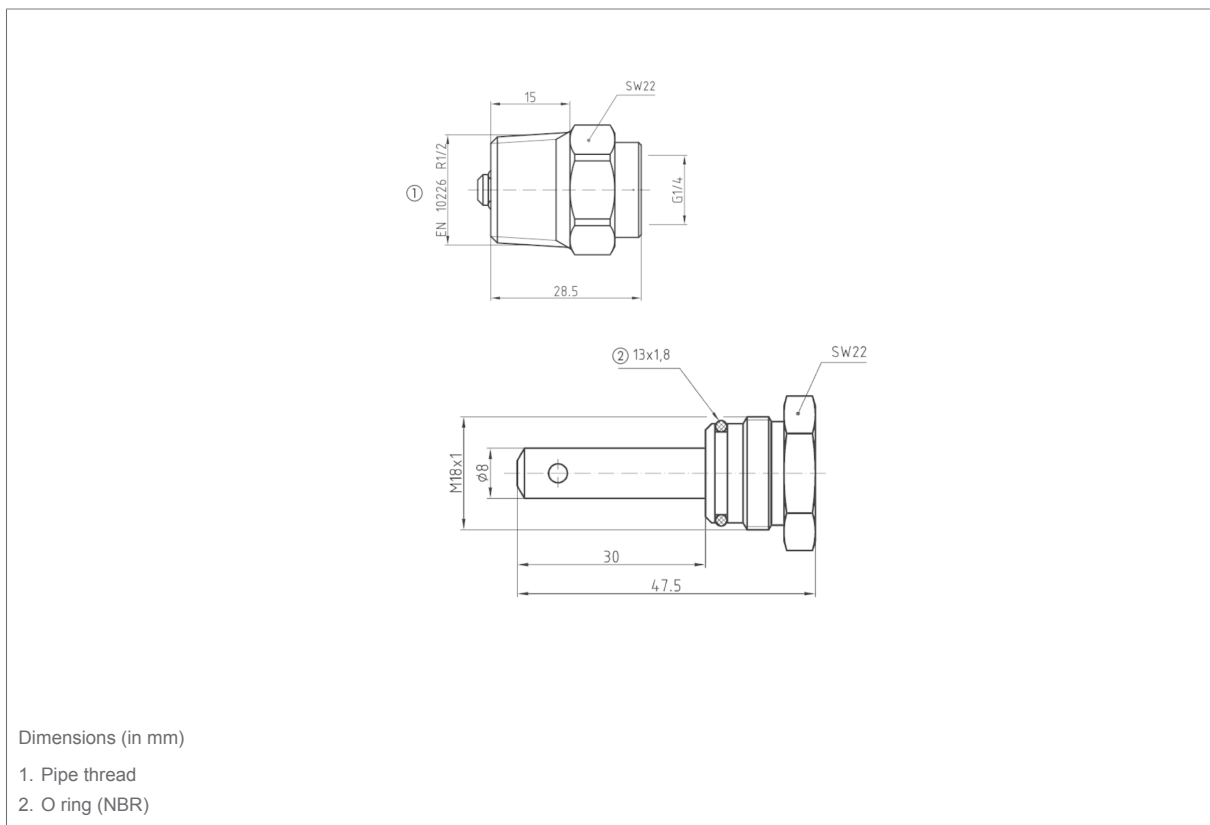



## Technical drawings

### Mounting valve and adapter

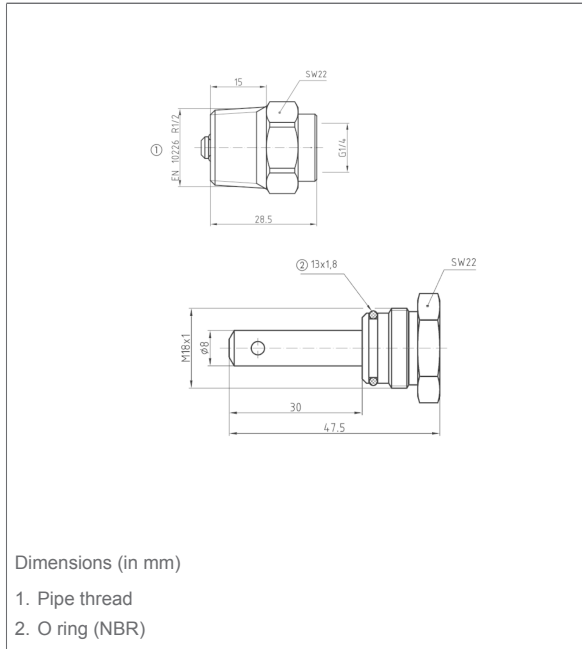

## Versions

Housing $\varnothing$	Housing	Mounting position	Range		Type	Part no.
			Pressure	Temperature		
80 mm	Sheet steel, black	Centre back	0/6 mWS	20/120 °C	TH80 D211	63311
80 mm	Sheet steel, black	Centre back	0/10 mWS	20/120 °C	TH80 D211	63312
80 mm	Sheet steel, black	Centre back	0/16 mWS	20/120 °C	TH80 D211	63313
80 mm	Sheet steel, black	Centre back	0/25 mWS	20/120 °C	TH80 D211	63314
80 mm	Sheet steel, black	Centre back	0/40 mWS	20/120 °C	TH80 D211	63315
80 mm	Sheet steel, black	Centre back	0/60 mWS	20/120 °C	TH80 D211	63316



Blue part no. = in-stock items